

## DALI LS/PD LI

DALI LS/PD LI | Sensors for light management systems



### Product family features

- Direct connection to DALI
- Light and presence sensor for luminaire installation
- Presence detection via passive IR element
- Light sensor operating range: 20...800 lx (measured at sensor)
- Function indicator with two-color LED
- Flame-resistant, halogen free polycarbonate plastic housing
- Mounting height: 2...5 m

### Product family benefits

- Small housing design
- Presence detection angle adjustable between 40...90° via integrated shutters
- Can be addressed via DALI
- Compact housing for luminaire installation
- Daylight-dependent control with automatic shutdown in adequate daylight
- Slim housing design and flexible mounting concept
- Power supply from DALI
- DALI based light management system integrable into building management systems
- Multiple sensors can be networked
- Sensor integration in DALI

## Product datasheet

---

### Areas of application

- Installation in industry and office luminaires
- Ceiling installation via LS/PD CI KIT or LS/PD AP KIT possible
- Classrooms
- Conference rooms
- Corridors
- Individual offices
- Suspended luminaires
- Suitable for indoor applications
- Open-plan offices

## Product datasheet

### Technical data

#### Dimensions & weight

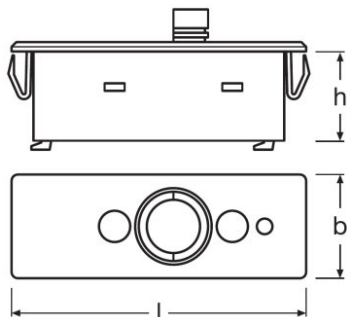

|                |         |
|----------------|---------|
| Length         | 48.0 mm |
| Width          | 15.0 mm |
| Height         | 17.0 mm |
| Product weight | 10.00 g |

#### Colors & materials

|               |      |
|---------------|------|
| Product color | Grey |
|---------------|------|

#### Temperatures & operating conditions

|                           |              |
|---------------------------|--------------|
| Ambient temperature range | -20...+50 °C |
|---------------------------|--------------|

#### Capabilities

|                               |   |
|-------------------------------|---|
| Maximum installation height   | 5 m                                       |
| Detection area                | 6 m <sup>1)</sup>                         |
| Detection angle               | 80 °                                      |
| Operating range, light sensor | 20...800 lx                               |
| Type of installation          | Ceiling integration/Luminaire integration |

<sup>1)</sup> Maximum diameter

#### Certificates & standards

|                    |      |
|--------------------|------|
| Type of protection | IP20 |
|--------------------|------|

#### Logistical data











|                |              |
|----------------|--------------|
| Commodity code | 853650199000 |
|----------------|--------------|

## Product datasheet

### Equipment / Accessories

- Suitable for many OSRAM DALI control systems
- Attachable mounting frame for luminaire mounting from inside and outside

### Download Data

| File  |  |
|---|--|
|    | User instruction<br>DALI LSPD LI   |
|    | Declarations of conformity<br>EC-DoC LMS Sensor Coupler and Sensor 9C1-3402820-EN-02 2019  |
|    | Declarations of conformity<br>334811_Declaration of conformity &#150; DALI PRO CONT-4 &#150; DALI PRO PB Coupler &#150; DALI PRO Sen |
|    | Declarations of conformity<br>EU Declaration of Conformity 2019_9C1_2874588_EN_09  |
|    | Operating instructions<br>377128_Manual DALI LSPD LI (D-EN-ES-FR-IT)   |
|    | Operating instructions<br>383606_Manual DALI LSPD LI (PL-CZ-SK-SL)   |
|  | Operating instructions<br>383607_Manual DALI LSPD LI (FI-DK-NO-SV)   |
|  | CAD data<br>DALI LSPD LI CAD Data  |
|  | CAD data 3-dim<br>DALI LS PD LI CAD Step   |
|  | CAD data 3-dim<br>DALI LS PD LI CAD X_T  |

### Logistical Data

| Product code  | Product description | Packaging unit (Pieces/Unit) | Dimensions (length x width x height) | Volume               | Gross weight |
|---------------|---------------------|------------------------------|--------------------------------------|----------------------|--------------|
| 4052899043954 | DALI LS/PD LI       | Shipping carton box<br>25    | 223 mm x 197 mm x 179 mm             | 7.86 dm <sup>3</sup> | 1131.00 g    |

The mentioned product code describes the smallest quantity unit which can be ordered. One shipping unit can contain one or more single products. When placing an order, for the quantity please enter single or multiples of a shipping unit.

## Product datasheet

---

### Disclaimer

Subject to change without notice. Errors and omission excepted. Always make sure to use the most recent release.